

USER MANUAL

GR05 HYDRAULIC ANGLE GRINDER (UNDERWATER TOOL)

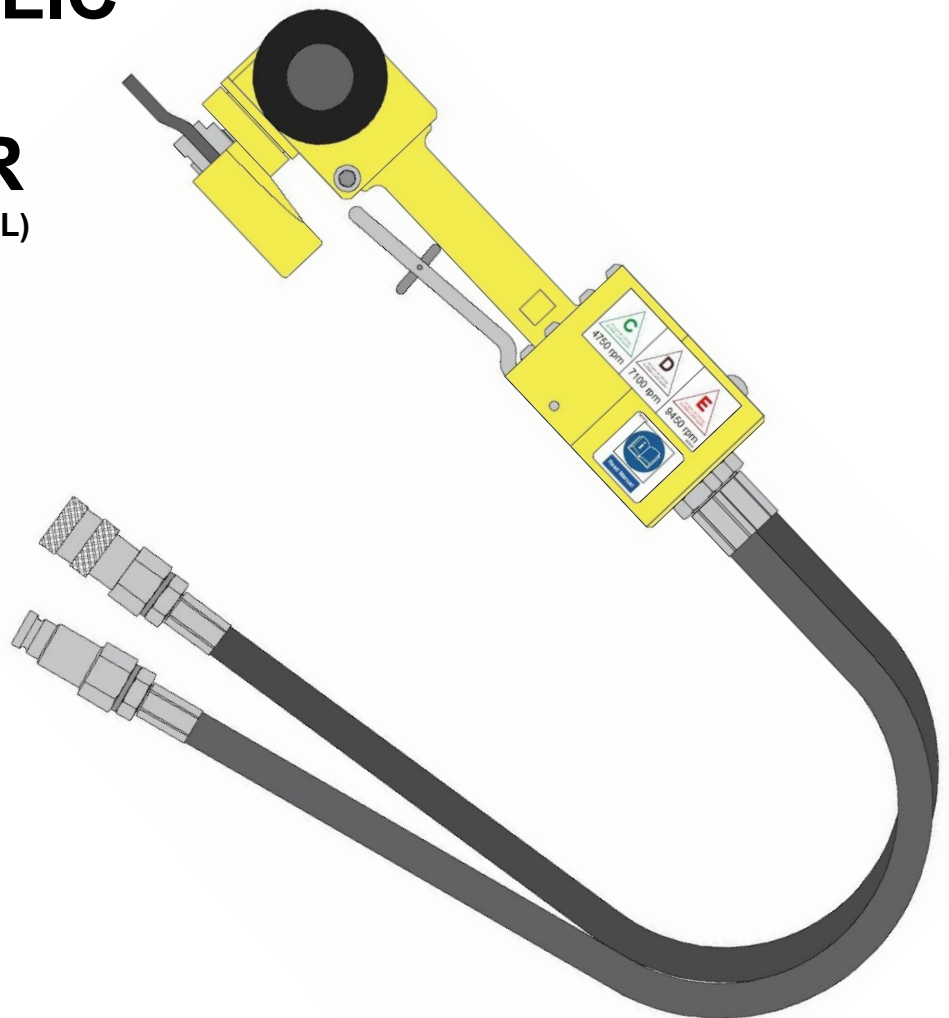

Version 6
(061125)

From Serial No. 0301

Hopkins

CONTENTS

TOPIC	PAGE
Contents (this page)	1
Safety Symbols	2
Safety Precautions	3
Disc Safety & Information	6
Product Description	7
Scope of Delivery	7
Intended Use	7
Identification & Labels	8
Specifications	9
Operation – Pre Use Checks	10
Operation – Preparation for Use	10
Operation – Startup and Use	10
Operation – After Use	11
Maintenance Instructions	12
Service Instructions	12
Storage	14
Tool Disposal	14
Parts Illustration	15
Parts List	16
Troubleshooting	17
Accessories	18
Hydraulic Hose Recommendations	21
EU Declaration of Conformity	22
Warranty	23





Technical Support: -

EC Hopkins Ltd
Unit 1, 82 Kettles Wood Drive
Woodgate Business Park
Birmingham B32 3DB UK

Tel: +44 (0)121 506 6095
Email: enquiries@echopkins.com

SAFETY SYMBOLS

This manual aims to provide the user with information to allow for the safe operation and maintenance of the power tool. The following symbols are used throughout this manual, they are included for your safety and for the protection of the power tool. Always observe and respect the safety symbols found throughout this manual, on equipment labels and information plates.

	<p>WARNING – Read the user manual Thoroughly read the user manual paying particular attention to all safety warnings, precautions and instructions. Failure to do so could result in tool damage and/or serious injury. DO NOT discard this manual, store in a safe place for future use.</p>
	<p>DANGER SYMBOL Indicates an imminently hazardous situation which will result in death or serious injury.</p>
	<p>WARNING SYMBOL Indicates a potentially hazardous situation which could result in death or serious injury.</p>
	<p>CAUTION SYMBOL Indicates a potentially hazardous situation which could result in product or property damage.</p>
	<p>NOTICE - Information / Helpful hints Indicates important and useful hints for handling, maintaining and servicing the tool throughout the user manual.</p>

GENERAL CAUTIONS AND WARNINGS



DO NOT operate this power tool without thoroughly reading this manual, take time to familiarise yourself with the power tool and its functions before use. Make sure you know how to use and maintain this equipment safely.



This power tool should only be used and operated by a competent person who has received adequate training in its operation. If there are any questions or anything is not clear, contact the manufacturer for further guidance and assistance.



It is the buyer or user's responsibility to ensure that the selected hydraulic power source is compatible for use with this power tool, check both hydraulic flow and pressure relief settings are within the rated range of the power tool.



Only personnel who have attended a recognised Abrasive Wheels Course and hold a valid certificate can fit abrasive wheels to the power tool. Ensure any accessory being fitted is compatible and speed rated within the tools maximum speed.



NEVER operate this power tool if you are ill, feeling tired, on medication or under the influence of alcohol or drugs. Your judgement will become impaired under any of these conditions and could lead to serious injury or death to you and/or others around you.



Other than routine maintenance, repairs and/or service to this power tool must only be carried out by a trained and competent person. Serious injury or death could result from the improper repair or service of this tool.



DO NOT modify or fit non-approved parts to the tool without prior written consent from the manufacturer, tool warranty will be voided without this. Failure to comply with this warning could result in serious injury or death.

SAFETY PRECAUTIONS

Operators and maintenance personnel must always comply with the safety precautions given in this manual and on the labels attached to the equipment.

These safety precautions are given for your safety, review them carefully before operating the power tool and before performing any maintenance or repairs.

Supervising personnel should develop additional precautions relating to the specific work area and local safety regulations. A risk assessment should be performed and procedures established before any work proceeds.

This power tool will provide safe and dependable service if operated in accordance with the precautions and instructions given in this manual. Thoroughly read and understand this manual and any labels attached to the equipment, failure to do so could result in personal injury or equipment damage.

Do not discard this manual, pass to the operator for their future reference. Copies are available on request or downloadable from our website.

PPE - PERSONAL PROTECTIVE EQUIPMENT

	Wear Eye Protection at all times when operating the power tool
	Wear Ear Protection at all times when operating the power tool
	Wear Respiratory Protection at all times when operating the power tool
	Wear Hand Protection at all times when operating the power tool
	Wear Safety Boots at all times when operating the power tool
	Wear Head Protection when performing overhead work
	Wear Fire-Retardant Garment(s) when deemed necessary

- Wear suitably rated protective equipment at all times when operating the power tool, these include but are not limited to safety goggles, ear defenders, respiratory mask, gloves, safety boots and head protection.
- If a risk assessment finds necessary wear approved fire-retardant garments covering arms, legs and body to protect from grinding sparks. Grinding sparks are extremely hot and can ignite clothing, have a bucket of water nearby.
- NEVER wear loose fitting clothing and remove all jewellery. Tie back long hair when operating the power tool. Loose items can become

entangled in the working parts of the tool and cause serious injury.

WORKING AREA / ENVIRONMENT

- Operator must start in a work area without bystanders. The operator must be familiar with all prohibited work areas such as excessive slopes and dangerous terrain conditions.
- Ensure the working area has adequate lighting, keep well-lit at all times.
- Ensure the working floor area is clear and dry to avoid tripping or slipping hazards.
- Assess and establish a method for hydraulic hose management, hoses within the working area can increase the risk of tripping if not managed correctly.
- Remove all clutter before proceeding to work, keep the working area clean.
- Ensure no personnel can wander in front or to the sides of the operator whilst using the power tool, consider cordoning off the area of working activity.
- DO NOT use the power tool in an explosive environment or near combustible materials.
- Remove all combustible materials and flammable liquids from the vicinity, the power tool will produce sparks whilst in use.
- Avoid using the power tool when there is dust or vapor nearby.
- Check the working area for buried utility cables or pipes, do not proceed to work where you cannot be sure of their presence.

GENERAL PRECAUTIONS

- DO NOT operate the power tool without first reading this user manual.
- DO NOT operate the power tool unless thoroughly trained or under the supervision of an instructor.
- Establish a training program for all operators to ensure safe operation of the power tool.
- DO NOT use the power tool for tasks other than those it was designed for, see intended use section of this manual.
- Keep all parts of your body away from the working area of the power tool.
- DO NOT inspect or clean the power tool while the power unit is running, accidental engagement of the tool can cause serious injury.
- DO NOT operate the power tool if there are any signs of damage. If the tool generates a problem while in use, stop immediately and report faults to your supervisor.
- DO NOT operate the power tool if it is missing parts or has been modified. All issues must be rectified before putting the tool to work.
- To prevent unintentional tool startup, ensure the trigger of the power tool is in the OFF position (not depressed) before powering up the hydraulic power unit and setting the circuit live.

- Disconnect the tool from the power unit when fitting or changing accessories. Do not work on the power tool while the hydraulic circuit is live.
- Check and ensure the speed rating of all grinding and cutting accessories are higher than the maximum rated speed of the power tool.
- When new grinding or cutting accessories have been fitted slowly accelerate the speed of the tool and check the accessory is running true and free of any abnormal vibrations. Remove and discard all that fail this procedure.
- NEVER use without the side assist handle fitted, hold the power tool with both hands at all times whilst operating.
- DO NOT overreach, ensure you keep your balance and a sure footing at all times.
- Avoid awkward and unsuitable postures, elect a comfortable stance while using this power tool.
- Ensure the work piece is secured and cannot move whilst grinding or cutting.
- Be aware that the nature of grinding with a power tool can and will generate high velocity projectiles, wear instructed PPE at all times.
- NEVER start the grinder with the tool in contact with a surface, always introduce the free spinning tool to the work piece.
- NEVER walk around with the grinder running.
- DO NOT continue to use the power tool if the system hydraulic oil exceeds 60°C, this will lead to operator discomfort and create a hazardous situation.
- Be aware that working surfaces will become hot while grinding or cutting, wear PPE at all times and avoid touching or coming into contact with recently worked surfaces.
- DO NOT walk or wander around with the tool activated and running, negligence such as this will invite accidents.
- DO NOT set the power tool down to rest until the spindle shaft has stopped rotating.
- DO NOT leave the power tool unattended while it is in a live / powered condition.
- Allow the power tool to cool before storing.
- DO NOT transport or store the power tool with accessories fitted.
- Always keep critical tool markings such as warning labels legible, replace any that are missing or damaged.
- To avoid personal injury or equipment damage, power tool maintenance, repair and service activities must only be carried out by competent and trained personnel.

SAFETY WHEEL GUARD AND DISCS

- Always fit the supplied safety wheel guard when operating the power tool with grinding and cutting discs, ensure the guard is securely clamped to the boss of the power tool.

- To protect the operator from flying projectiles, ensure the wheel guard is positioned correctly with the closed side towards the operator.
- DO NOT use the power tool with a loosely fitted safety wheel guard.
- DO NOT adjust the safety wheel guard while working with the tool, remove power from the tool before making any adjustments.
- NEVER use a damaged abrasive grinding or cutting disc, inspect all discs for damage, cracks, excessive or uneven wear. Discard any disc that has defects or has been dropped.
- DO NOT forcibly fit an abrasive grinding or cutting disc as this will pre-stress the disc and may lead to premature failure.
- DO NOT use non-reinforced abrasive grinding or cutting discs with this power tool.
- DO NOT use a cutting disc to grind with, side loading an abrasive cutting disc can cause the disc to shatter.
- DO NOT use toothed saw blades as these will increase the risk of kickback.
- DO NOT use worn down discs from larger tools, they will not be compatible with this grinder.
- DO NOT use reducing bushes to enable the fitting of discs with a larger hub size.
- When cutting do not twist or force the disc to cut as this can cause the disc to shatter. Guide the disc in a straight line applying gentle pressure.

NOISE

- Exposure to high noise levels can cause permanent hearing loss and other problems such as tinnitus. Always use ear protection as instructed by your employer and in accordance with occupational health and safety regulations.
- Apply additional controls, if possible (such as material damping) to help reduce the noise generated by work piece materials.
- Maintain and keep the power tool in perfect working condition to help prevent unnecessary increases in noise levels.

DUST AND FUMES

- Some dust created by grinding and cutting activities in construction materials is known to contain chemicals that cause cancer, birth defects and other reproductive harm.
- Risk of exposure varies and depends on how frequent you carry out this work.
- A risk assessment must be carried to help identify the composition of the material to be worked, to specify the type of respiratory protection to be used and to identify any national health and safety regulations to be followed.
- Work in a well-ventilated area to help reduce the exposure level to these chemicals.
- Consider the immediate working area, protect yourself and others around you.

- If appropriate arrange for the safe disposal of materials by a registered and qualified waste disposal body.
- Be aware that the dust and fumes that are being created by the working activity could cause a potentially explosive environment. Take precautions.
- If possible, use some qualified form of dust extraction at the point of emission to control and minimise the amount of dust entering the atmosphere.
- Always use respiratory protection as instructed by your employer and in accordance with occupational health and safety regulations.
- Maintain and keep the power tool in perfect working condition and only use the tool as instructed by this manual.
- Avoid prolonged contact with the dust, keep contact to an absolute minimum.
- DO NOT use this tool on asbestos.

VIBRATION

- Working with power tools will expose operators to levels of vibration. Operators can experience discomfort in the hands, arms and shoulders, neck or other parts of the body as a result.
- If you experience any signs of tingling, pain, numbness or whitening of the fingers or hands, immediately stop using the power tool. Inform your employer and seek medical attention.
- To help reduce the effects of vibration on the body when working in cold weather conditions, wear thermal clothing and keep hands and arms warm and dry.
- Maintain and keep the power tool in perfect working condition to help prevent unnecessary increases in vibration levels and only use the tool as instructed by this manual.
- It is good practice to carry out periodic vibration tests on all power tools in the working environment, if higher than normal vibration figures are recorded have the power tool serviced by an authorised service and repair centre.

HYDRAULICS

- Check the selected hydraulic power unit flow and pressure specifications are fully compatible with this power tool before connection and use.
- DO NOT power this tool from a hydraulic power source with flow and pressure values that exceed the specifications of this power tool.
- NEVER connect hydraulic hoses to the power tool with the power unit powered up and running.
- Only use hydraulic hoses that have a working pressure specification that exceeds the maximum pressure of the power unit.
- Check all hoses are connected for correct hydraulic flow direction / rotation of the tool.

- DO NOT use the tool in reverse direction.
- Regularly inspect hydraulic hose whips for damage and signs of perishing, replace if any noted.
- DO NOT inspect hoses for leaks by using bare hands as 'pin-hole' leaks can penetrate the skin.
- Should hydraulic oil penetrate the skin or is inadvertently swallowed, seek medical advice immediately. DO NOT induce vomiting.
- NEVER use the power tool if there is any evidence of hydraulic oil leaking.
- Should any oils or greases come into contact with bare skin, wash off immediately with warm soapy water. Skin conditions such as dry skin or eczema can occur if ignored.

KICKBACK

- Be aware of kickback during operation. This happens when a cutting disc is misaligned, binds or is pinched in the work piece. The power tool reacts violently lifting out of the work piece and back towards the operator and could result in serious injury if the disc shatters.
- Kickback occurs due to operator error and injury can be avoided by taking proper precautions and following the procedures listed as following.
- Using both hands, grip the grinder firmly around the trigger / handle body and at the side assist handle. Always use both hands when operating and be prepared for the unexpected when using.
- Position your body away from the line of any potential kickback.
- When using a cutting disc always cut in a straight line. Do not twist the disc or try to cut round corners, this puts a side load on the disc and it will either jam or shatter with the potential of causing kickback.
- DO NOT force the disc to cut, only apply light pressure and let the disc do the work.
- NEVER start the grinder with the disc in contact with the work piece, introduce a free spinning disc slowly to the work piece.
- REMEMBER: Complacency can be a killer. The attitude of 'I've been using a grinder for years, I know what I am doing, it's never happened to me' could be your undoing. Stay Alert, Stay Alive!

UNDERWATER

- Only commercial divers with the correct level of training should be allowed to use power tools in an underwater environment.
- As most of the PPE advised throughout this manual will not be suitable for use in an underwater environment, this will need to be carefully substituted with the appropriate versions of diving wear. Consult your local commercial diving association for advice and guidance with this.

DISC SAFETY & INFORMATION

Always be sure to comply with all the accident prevention regulations when using grinding discs and cut-off wheels. The appropriate industrial safety pictograms are found on all discs and wheels.



Wear safety goggles or glasses



Wear hearing protection



Wear safety gloves



Wear respiratory protection



Observe safety instructions



DO NOT use for side grinding



DO NOT use if broken

General Safety Guidelines

Check cut-off / grinding wheel etc. for damage before use.

Ensure tool speed does not exceed maximum rated speed of cut-off / grinding wheel etc.

Disconnect power source before changing wheels or when tool is not in use for extended periods.

Ensure work piece is secure.

Always wear appropriate personal protective equipment (PPE).

Never breach any restrictions to use **i.e.**
DO NOT use if broken.
DO NOT use cutting disc for grinding.

Grinding Wheel Use

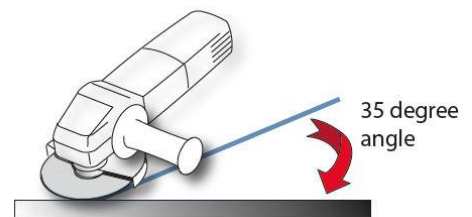

Cut-Off Wheel Use

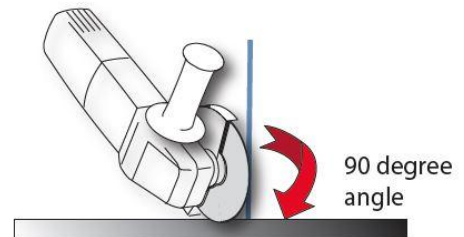

Mop Wheel Use

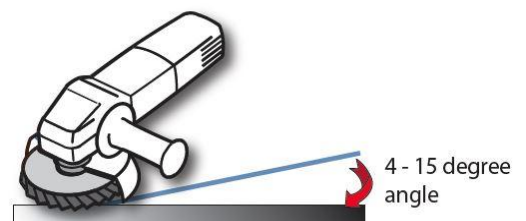

Proper Tool Mounting

Depressed Centre Grinding Wheels

Wheels with 4 to 10mm thickness

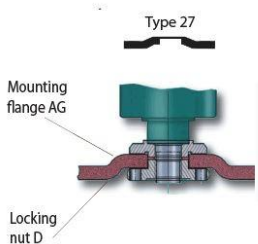

Flat and Depressed Centre Cut-Off Wheels

Wheels with 1 to 4mm thickness

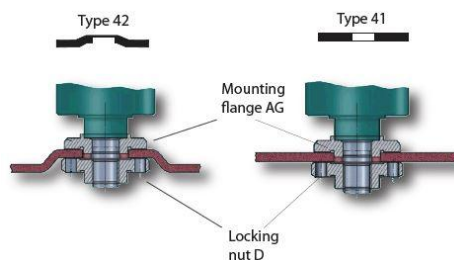

PRODUCT DESCRIPTION

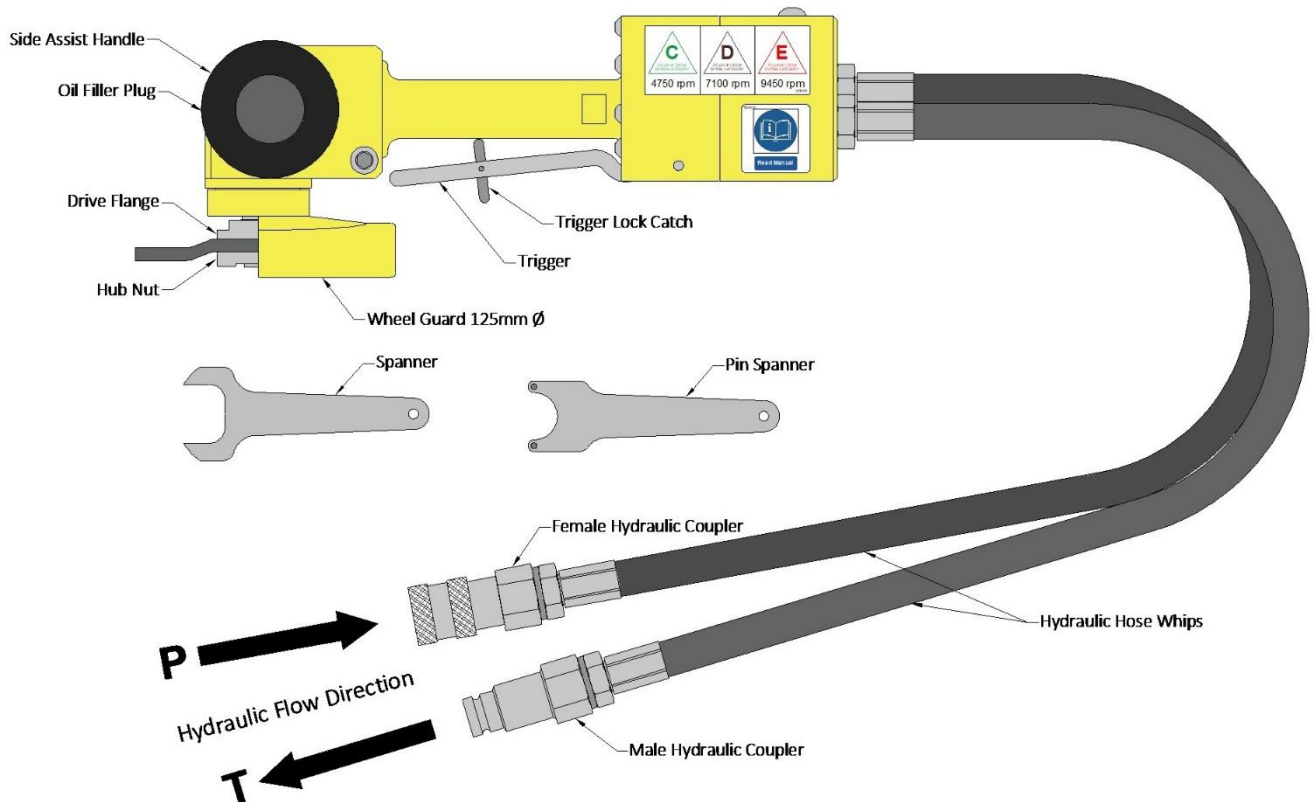

SCOPE OF DELIVERY

- 1 x Hydraulic Angle Grinder fitted with 1m hose whips & couplers
- 1 x Wheel Guard, Drive Flange & Hub Nut (fitted to tool)
- 1 x Side Assist Handle
- 1 x Flange Spanner
- 1 x Pin Spanner
- 1 x ALL-CUT Diamond Grit Cutting Disc
- 1 x ALL-GRIND Diamond Grit Grinding Disc
- 1 x Protective Tool Case
- 1 x User Manual

INTENDED USE

The GR05 Hydraulic Angle Grinder is a portable handheld lightweight tool designed to be operated with both hands.

It is intended to be used for grinding, sanding, cutting and cleaning operations of metal and stone materials in an underwater environment, both fresh and saltwater.

Use above water is not recommended as this will overheat the tool and compromise the bearing shaft seal. However, a brief run of no more than 15 seconds above water to check for oil leaks and correct rotation is acceptable.

LABELS & IDENTIFICATION

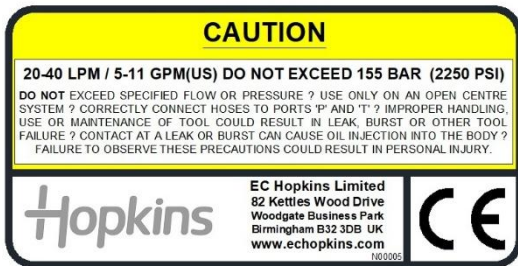
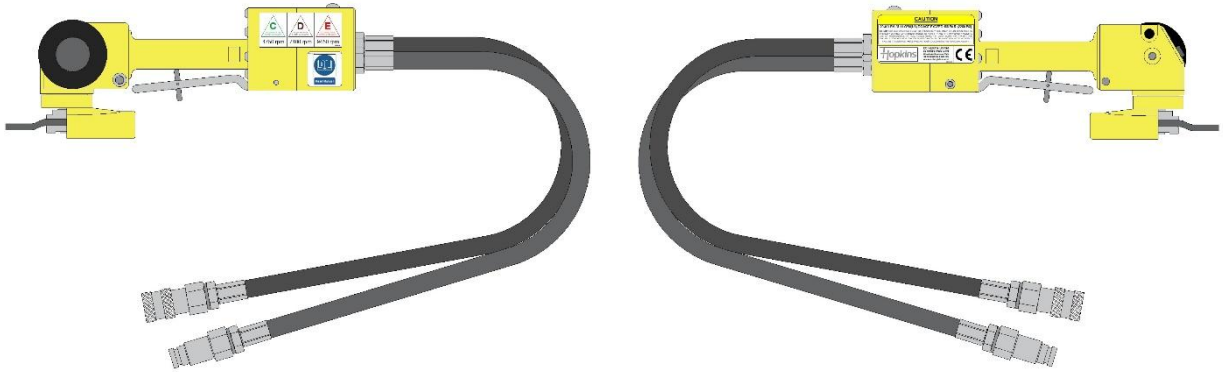

N00005 Caution

HYDRAULIC PORTS
 P: Supply Port
 T: Return Port

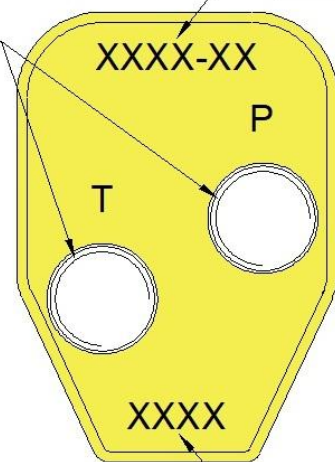

Model Number

Serial Number

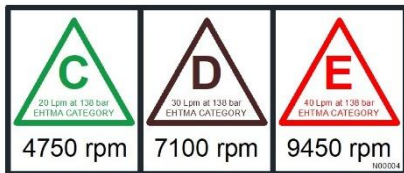

N00004 EHTMA Category

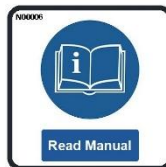

N00006 Safety

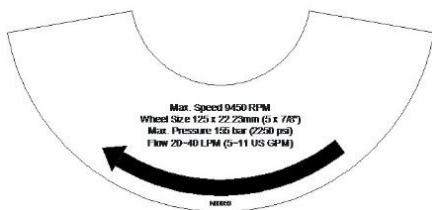

N00059 Rotation

SPECIFICATIONS

TOOL MODEL & TYPE	GR05 Hydraulic Angle Grinder Underwater	
HYDRAULIC REQUIREMENTS Input Flow Range Optimum Flow Rate Maximum Flow Rate System Pressure Back Pressure Oil Viscosity Grade System Type	20 ~ 40 lpm (5 ~ 11 USGPM) 30 lpm (8 USGPM) 40 lpm (11 USGPM) 155 bar (2250 psi) MAX 17 bar (250 psi) MAX Grade 32 mineral or biodegradable oil Open Centre (OC)	
HYDRAULIC CONNECTION Tool Ports Hose Whips Hyd QR Couplers	-8 SAE O-Ring 1m Long Flat Face 1/2" BSP (3/8" Body Size)	
HYDRAULIC TOOL CATEGORY HTMA EHTMA	Type I, Type II CAT C, D, E	
CAPACITY Disc Size Disc Type Spindle Thread	125mm (5") Diameter x 22.23mm (7/8") Bore Type 27, 41 & 42 GR05-01: M14 Threaded Spindle GR05-02: 5/8-11 UNC Threaded Spindle	
TOOL PERFORMANCE Spindle Speed Rotation	9450rpm @ 40lpm EHTMA CAT E 7100rpm @ 30lpm EHTMA CAT D 4750rpm @ 20lpm EHTMA CAT C CCW (viewed from spindle end)	
LUBRICATION Oil in Handle	15W/40	
DIMENSIONS Length (without guard & hoses) Width (without guard & side handle) Width (with guard / without side handle) Height (with guard) Guard Diameter	322mm 65mm 141mm 133mm 141mm ø	
WEIGHT (without hoses)	3.3 kg	
SOUND PRESSURE LEVEL L_{PA} (1m)	91 db(A) Measured	Uncertainty K: 3 db(A)
SOUND POWER LEVEL L_{WA}	102 db(A) Measured	
VIBRATION – Trigger Handle	4.3 m/s ² Measured	Uncertainty K: 1.5 m/s ²
VIBRATION – Side Assist Handle	4.5 m/s ² Measured	Uncertainty K: 1.5 m/s ²

OPERATION



WARNING

Read and fully understand operator's manual before using this machine.

DO NOT operate this hydraulic power tool until you have thoroughly read this manual and familiarized yourself with all tool functions.

PRE USE CHECKS



DO NOT perform these checks with the tool connected to the power source, disconnect the tool before proceeding.

Check the hydraulic hose whips are not showing any signs of damage, exposed wire braiding or perishing.

Check the hydraulic couplers are in good condition with no signs of oil leaks.

Check the tool for any signs of oil leaks.

Check all fasteners are tight and secure.

Check both the trigger and safety catch operate and move freely.

Check the tool for any missing, damaged or defective parts paying particular attention to the safety wheel guard.

Replace all missing, damaged and/or defective items identified throughout the pre-use checks before proceeding to use the tool.

Further tool checks are listed and advised under the Maintenance section of this manual.

PREPERATION FOR USE



DO NOT fit or change accessories with the tool connected to the power source, disconnect the tool before proceeding.

Select the correct type of accessory for the job in hand, ensure the selected accessory is compatible with this tool and the rpm rating meets or exceeds the max speed of the tool. See specifications page for further information.



DO NOT use any discs or accessories that are damaged, deformed or defective. Discard and dispose of all damaged accessories.

Ensure the safety wheel guard is securely fitted and locked to the hub of the power tool, this has a quick release catch which can be tension adjusted with a screwdriver if needed.



NEVER use the power tool with grinding or cutting discs without the safety wheel guard fitted.

Remove the hub nut from the threaded spindle of the power tool. Ensure the drive flange is

fitted the correct way round with the slot of the flange securely mounting over the shoulder flats of the threaded spindle.

Fit the selected grinding or cutting disc to the flange ensuring the bore of the disc is a snug fit to the centring boss of the flange. If fitting a DPC (Depressed Centre) disc, ensure the depressed centre mounts against the drive flange and projects away from the power tool.



We strongly recommend using our AG125-22 ALL-GRIND or AC125-22 ALL-CUT diamond grit discs for all grinding and cutting tasks, these discs do not have a life expiry and can be submerged infinite times in fresh and salt water without compromising their integrity. Bonded abrasive discs may be used but they must be destroyed and disposed of after each task.

Refit the hub nut to the threaded spindle of the power tool and lock in position using the included spanners; secure the drive flange with the 30mm spanner and using the pin spanner tighten the hub nut to lock the disc in place.



DO NOT overtighten the hub nut as this could deform the grinding or cutting disc and compromise its integrity.

The hub nut is handed to suit the mounting of both cutting and grinding discs, fit hub nut the correct way round according to the disc type being used. i.e. centring boss of hub nut facing towards grinding discs and facing away from cutting discs.

Adjust / orientate the position of the safety wheel guard so that the closed section of the guard falls between the operator and the grinding or cutting disc, lock in position with the guard quick release catch.

Depending on the operator preference fit the side assist handle to one of the handle mounting points located at either side of the gearbox housing, hand tighten in place.

This power tool may also be used with a range of centre threaded brushes; these can be used with this power tool by removing the drive flange, hub nut and if necessary, the safety wheel guard. The brushes are mounted directly to the threaded spindle of the power tool or via a centre threaded brush adaptor plate.



Depending on the build number the tool will be supplied with either a M14 or 5/8-11 UNC threaded spindle.

Select a suitable hydraulic power unit (HPU) to power this tool, ensure the hydraulic circuit is of the open centre (OC) type. Check and make sure that the hydraulic power unit does not exceed a maximum output flow of 40 Litres per Minute and that the maximum system pressure is set to no more than 155 Bar (2250 psi). It is advisable to test the selected HPU with a calibrated hydraulic flow & pressure tester to ensure compatibility with the tool.

Connect a suitable main set of commissioned hydraulic hoses (see hydraulic hose section) between the HPU and tool, wipe the faces of all hydraulic couplings with a clean cloth before making any connections. Connect the return hose first followed by the pressure hose and ensure flow direction of the hydraulic circuit is correct i.e. flow supply from HPU to 'P' port of tool and 'R' port of tool to flow return of HPU.

As the coupling connection is being made the sleeve of the female coupling will spring forward to latch the connection. Once made twist the sleeve approximately 90 degrees in either direction to mis-align the notch of the sleeve and pip of the coupling body, this function will prevent the coupling connection from unintentionally disconnecting. When ready to disconnect, realign the notch and pip and pull back the sleeve of the coupling body.

 Industry convention is that hydraulic oil flows out of the male coupler and returns through the female coupler.

FLOW DIRECTION

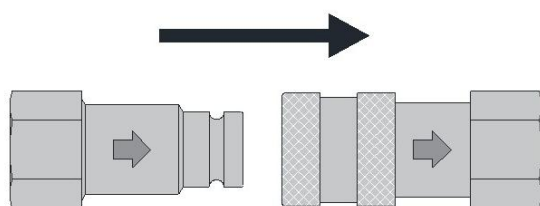

START UP AND USE

Follow the startup procedure for the HPU and power up, refer to HPU user manual. Move the 'ON/OFF' lever of the HPU to the 'ON' position – the hydraulic circuit and tool is now LIVE.

Using both hands, grip the grinder firmly around the trigger / handle body and at the side assist

handle. With a firm footing, release the trigger lock mechanism and slowly squeeze the trigger. At startup ensure the disc is rotating in the correct direction - CCW when viewed from spindle end of tool.



ALWAYS use both hands when operating this tool.



DO NOT start grinder with the disc in contact with the work surface.

Run the grinder for 15 seconds and check for oil leaks or any unusual noises / vibrations, stop immediately if any are noted. Refer to the trouble shooting section for possible causes.



DO NOT run the tool out of water for more than 15 seconds as it could overheat and damage the shaft seal.

Should it require a longer test, submerge the front end of the grinder in a bucket of water so as not to overheat the tool or shaft seal.

Release the trigger to stop the tool, ensure the trigger lock mechanism returns to the lockout position.

Once the grinding or cutting task is complete and the tool disc has come to rest, set the tool down in a stable position and location.



Ensure the disc has come to rest before setting down the tool.

AFTER USE

Move the 'ON/OFF' lever of the HPU to the 'OFF' position and following the shutdown procedure power down the HPU.

Disconnect the tool from the main set of hydraulic hoses, when disconnecting uncouple the pressure hose first and the return hose last so as to minimize any pressure being trapped in the tool.

Remove any accessories fitted to the tool, discard if damaged or excessively worn.

Check the tool for oil leaks and damage, report any noted faults to your supervisor.

Wash the tool off with clean fresh water and work a light water dispersing oil to the moving parts e.g. valve spool, trigger and safety catch.

Place the tool in its protective tool case and store away in a clean dry environment.

MAINTENANCE AND SERVICE

MAINTENANCE INSTRUCTIONS



Disconnect tool from the hydraulic power supply before carrying out any maintenance or service work.

Hydraulic tools in general need very little maintenance but they do rely on good maintenance of the hydraulic power supply to fully realize the reliability and longevity that these tools can offer. Particular attention should be paid to the following practices to ensure a good and reliable experience with these tools:

- Regular hydraulic filter changes.
- Regular hydraulic oil changes.
- Cleaning of hydraulic coupler faces before connecting.

DAILY TOOL CHECKS

Visually check the tool for any signs of oil leaks, replace any suspicious seals as required.

Check condition of hydraulic hose whips, replace any that are damaged or showing signs of perishing.

Check hydraulic quick release connectors for leaks and damage, replace if necessary. Always replace both connectors.

Remove oil filler plug fitted to gearbox housing and check level, top up with 15W/40 oil if necessary. Refit oil plug and tighten to 3Nm.

Check safety wheel guard for damage and/or deformities, replace with new if necessary.

Check trigger safety lock is present and working correctly, replace any missing or broken parts.

Check action of trigger / valve spool interaction i.e. valve spool moves with a smooth action and returns to OFF position when trigger released, replace valve spool seals if required.

Check all fasteners are tight and secure.

Check all tool labels are present and legible, replace any that are missing or damaged.

EVERY 100 HOURS OR 12-MONTHS

Remove oil filler plug fitted to gearbox housing and drain oil into a suitable container. Refill with fresh 15W/40 oil and refit oil plug tightening to 3Nm. Run the tool for no more than 15 seconds and recheck oil level, top up if necessary.

Perform a spindle speed test and maintain a dated record of the result in the notes section of this manual. Using a calibrated hydraulic flow & pressure tester check the output of the hydraulic power source to ensure the hydraulic flow matches the specifications of this tool, see relevant section in this manual for details. Connect the tool to the hydraulic power source and with a calibrated contact tachometer record

the spindle speed of the tool at the matched hydraulic flow and record the result. Ensure the recorded spindle speed does not exceed the maximum speed of the tool when run at the matched flow (see specifications page) and is no less than 95% of the rated speed. A recording of less than 95% would suggest a worn hydraulic motor and the need for a major service and overhaul. In this instance send the tool to your local authorized repair centre.

SERVICE INSTRUCTIONS

PRIOR TO DISASSEMBLY

Clean the exterior of the tool removing as much foreign matter such as dirt and grit as possible.

Obtain Seal Kit (N00081) so that all exposed seals during disassembly can be replaced during reassembly. Note seal orientations before removal so that new seals can be fitted in the same positions as the original seals.

DISASSEMBLY

Using the 2 spanners included in the power tool kit unscrew and remove the hub nut (2), drive flange (3) and any fitted discs or accessories.

Release the quick locking catch of the safety wheel guard (49) and remove from the hub.

Remove the hydraulic hose whips (52) and allow the hydraulic oil from both hoses and tool ports to drain into a suitable container.

Using a 5mm hex key remove the filler plug (42) and drain the oil from the gearbox housing (35) into a suitable container.

Using a 4mm hex key remove the trigger pivot screw (16). Unhook the trigger assy (13) from the valve spool (20) and remove.

Using a 6mm hex key remove the gearbox housing screw (8) and separate the gearbox housing (35) from the handle housing (34).

Using a 3mm hex key remove the 4 x CSK screws (45) and separate the bearing housing assy (4) from the gearbox housing (35).

Lock the bearing housing assy (4) in a vice by clamping on the flats of the bearing shaft (1). Using a flat bladed screwdriver undo and remove the large pan head screw (41). Using a 2.5mm hex key loosen the 2 x grubscrews of the mitre gear (43) a couple of turns. Slide the mitre gear off the drive shaft and remove the drive key (7) and shim washer(s) (44). Using a suitable drift drive the bearing shaft (1) through the housing bearings (5) & (36) and shaft seal (46), remove from the housing (4).

Remove shaft seal (46) from housing (4).

Remove bearings (5) & (36) from bearing pockets of housing (4). It is best to warm up the

housing first then tap these out using a suitable drift. Fit new bearings whilst the housing is still warm.

Using a 5mm hex key and a large flat bladed screwdriver remove the button screw (25) from the valve spool (20). Remove the valve spring washer (24) and spring (23) from the end of the valve spool then withdraw the valve spool from the trigger side of the valve block (22).

Using a 4mm hex key remove the eight button head screws (32), the tool will separate into two sections: valve block assy (22) and handle c/w gear handle housing (34 & 29).

Remove both drive and idle gears (18 & 28). Clamp the gear handle housing (29) in a vice fitted with soft jaws and unscrew the handle (34) using a 1" AF open ended spanner.

Using a suitable bearing extraction tool remove the drive shaft bearing (14) from the bearing pocket of the gear handle housing. Remove the seal spacer (15) and shaft seal (17).

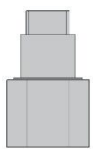

Clamp service tool N00257 in a vice and sit the handle housing (34) onto the service tool locating its tang into the recessed drive slot of the drive shaft (33). Using a flat bladed screwdriver undo and remove the large pan head screw (41). Rotate the mitre gear (40) to line up one of its 2 locking grub screws with the access slot of the handle housing and using a 2.5mm hex key loosen the grub screw a couple of turns, repeat this procedure for the remaining grub screw. Slide the mitre gear off the drive shaft and remove the drive key (7) and bearing spacer (38).

Using a suitable drift, drive the drive shaft (33) through handle bearing (36) and remove from handle (34).

Using a set of internal circlip pliers remove circlip (37) from the nose end of handle (34).

Remove bearing (36) from bearing pocket of handle (34). It is best to warm up the handle first then tap this out using a suitable drift. Fit a new bearing whilst the housing is still warm.

Remove all seals and discard.

REASSEMBLY

Assembly is the reverse procedure of the above with consideration of the following notes.

Thoroughly wash, degrease and dry all parts before proceeding with reassembly.

Inspect all components for excessive wear and damage, replace with new parts as necessary. Pay particular attention to condition of bushings

and seal contact areas on rotary shafts. Replace all bushings if they are showing signs of excessive wear ensuring they are driven fractionally below the surface of the housing when fitting. Inspect the condition of the gear cavity in the gear handle housing, replace the housing if excessive wear is present.

With new bearings fitted, lubricate all new seals with a high temperature lithium-based grease and fit to seal pockets. Lubricate seal pockets and seal contact surfaces in addition to seals.

Tighten all threaded fasteners to torque settings advised in the remarks section of the parts list.

Before fitting a new drive shaft bearing (14) ensure the drive shaft seal (17) and bearing spacer (15) have been fitted to the pocket of the gear handle housing (29) taking care to sit the flat surface of the spacer against the seal i.e. spacer step toward the bearing to be fitted. Offer the drive shaft bearing to the same pocket and with a suitable drift partially drive the bearing into the pocket until it is approx. 1mm proud of the pocket surface, ensure the bearing is driven reasonably true to the pocket. Offer and screw the handle (34) into the housing, hand tighten until the step at the front of the large M35 thread bottoms to the bearing outer race. With a 1" AF open ended spanner continue to tighten the handle into the pocket, a little resistance will be felt while the step of the handle trues up the bearing and drives it deeper into the bearing pocket and ultimately securing against the seal spacer and shaft seal. The handle is fully fitted once the large shoulder has bottomed to the outer pocket of the gear handle housing, both surfaces need to be perfectly flush to confirm and the spanner flats should finish parallel to the gear handle housing.

Tighten the eight button head motor screws (32) in opposing sequence stages ensuring the drive shaft rotates freely throughout.

Fit new O-rings (51) to the hydraulic hose whips and reassemble to the tool ports. The hose with the female coupling (knurled sleeve) fits to the 'P' port and the hose with the male coupling fits to the 'T' port.

Position the assembled tool with the filler port of the gearbox housing uppermost. Completely fill the gearbox / handle cavity (approx. 20ml) with 15W/40 oil. Fit and tighten the oil filler plug (42).

Finally run the grinder and check for any oil leaks. Remember DO NOT run out of water for longer than 15 seconds.

STORAGE

- Wash the tool off with clean fresh water and work a light water dispersing oil to the moving parts such as the valve spool, trigger and safety catch.
- Place the tool in its protective tool case along with its wheel guard and accessories.
- Store the tool in a clean and dry location.

TOOL DISPOSAL

At the point of retiring, this tool contains many components which can be recycled, please act responsibly and dispose of individual items in accordance with local and national environmental regulations.

Hydraulic Hoses

Drain waste oil from all hydraulic hoses and collect into a suitable container for recycling. Dispose of drained hoses by dropping them off or having them collected by a registered waste hose facility. Note: Hydraulic oil is hazardous to the environment, DO NOT allow waste oil to contaminate the ground or water table.

Hydraulic Oil

Collect all waste oil in a suitable container for recycling purposes, contact your local waste oil recycling facility for collection or drop off instructions. Note: Hydraulic oil is hazardous to the environment, DO NOT allow waste oil to contaminate the ground or water table.

Tool Body

Drain waste oil from the retired tool and collect in a suitable container for recycling purposes. Strip the tool and dispose of all non-metallic parts. Contact your local recycling facility for guidance and instructions on recycling metal items.

PARTS ILLUSTRATION

Serial No 0301 onwards

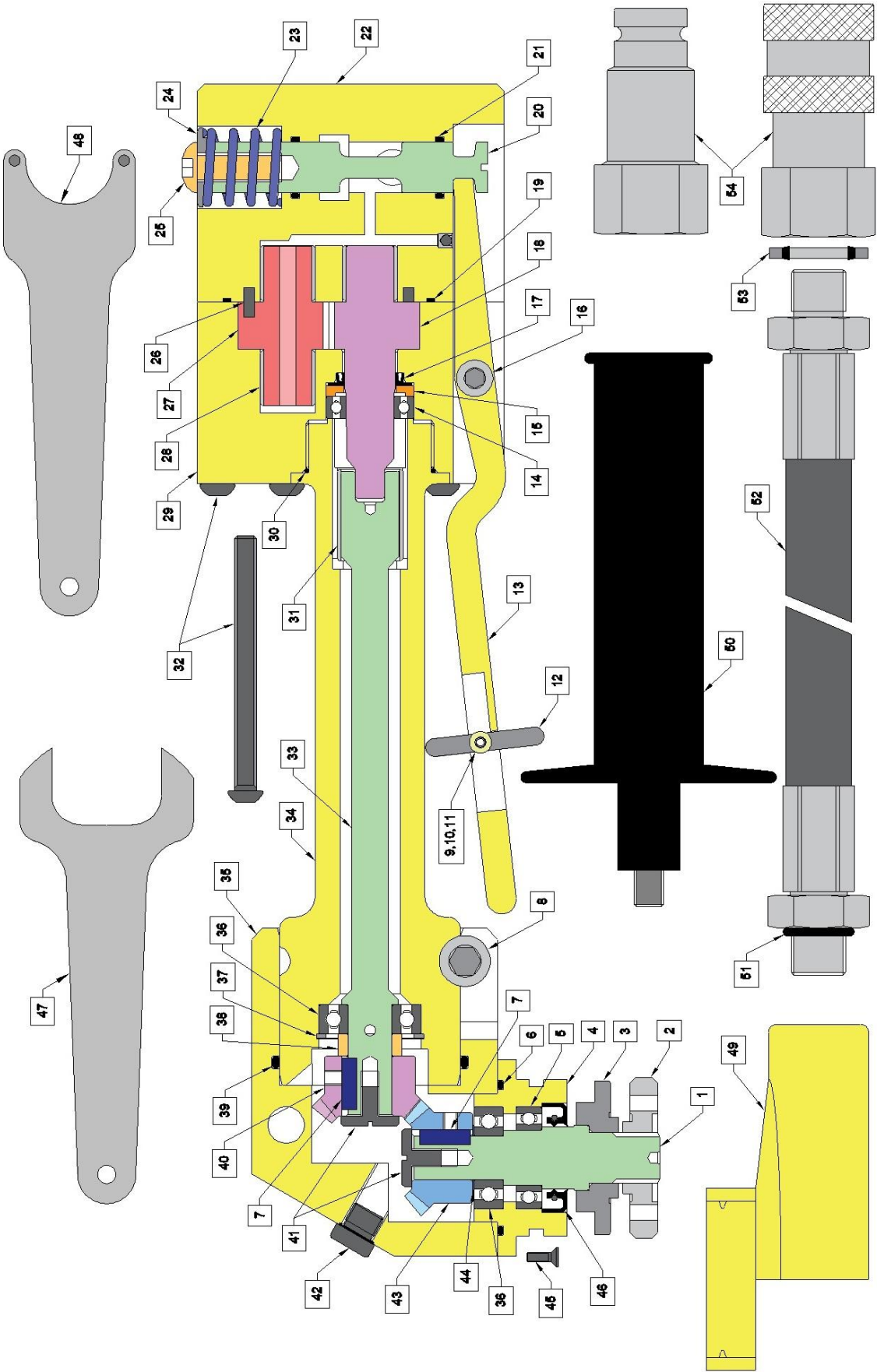

TROUBLESHOOTING

Below are various types of faults that may be encountered. Should a fault persist please call our technical helpline for assistance.

Problem	Probable Cause	Remedy
Grinder does not start	Tool not connected to HPU	Connect hydraulic hoses
	HPU circuit not switched on	Switch HPU hydraulic circuit on
	HPU is defective	Refer to troubleshooting section in HPU manual
	Hydraulic couplers are blocked	Replace blocked couplers
	Mechanical failure with tool	Send tool to service/repair centre
Grinder runs too slow	Hydraulic oil flow from HPU is set too low	Flow test HPU for correct hydraulic flow range
	Excessive back pressure	Check return line for restrictions
	Hydraulic oil viscosity is too thick	Change to thinner viscosity
	HPU hydraulic pump is worn	Refer to HPU manual and replace hydraulic pump
	Tools hydraulic motor is worn	Send tool to service/repair centre
Grinder runs too fast	Hydraulic oil flow from HPU set too high	Flow test HPU for correct hydraulic flow range
Grinder gets hot	Incorrect hydraulic flow from HPU	Flow test HPU for correct hydraulic flow range
	Running tool above water	Only operate tool underwater
	HPU oil cooler not working	Refer to HPU manual
	HPU oil cooler matrix fowled	Remove any obstructions
	HPU hydraulic pump is worn	Refer to HPU manual and replace hydraulic pump
Grinder lacks power	HPU pressure relief valve set too low, stuck open or faulty	Reset or replace HPU pressure relief valve
Grinder runs in reverse	Feed & Return hoses fitted the wrong way round	Check system for correct flow path and rectify
Oil leaking around bearing shaft	Bearing shaft seal worn	Fit new bearing shaft seal
Oil leaking from valve spool	Valve spool seals worn	Fit new valve spool seals
Hydraulic couplings will not connect	Hydraulic pressure locked in tool and hose whips	Loosen one of the hydraulic couplers to release the trapped pressure, retighten once done

ACCESSORIES

Type Description Application Materials Part Number Size Max Rating	5" All-Grind Diamond Grit Grinding Disc Durable, Long Life with the ability to grind a wide range of materials General Grinding / Various Materials All Purpose, Concrete, Stone, Steel & Alloys, Composite, PVC, Wood AG125-22 125mm 12,250rpm	
Type Description Application Materials Part Number Size Max Rating	5" All-Cut Diamond Grit Cutting Disc Durable, Long Life with the ability to cut a wide range of materials General Cutting / Various Materials All Purpose, Concrete, Stone, Steel & Alloys, Composite, PVC, Wood AC125-22 125mm x 2.5mm 12,250rpm	
Type Description Application Materials Part Number Size Max Rating	5" Diamond Cutting Disc DT 600 U Fast Cutting Performance, Long Life Cutting Concrete, Stone, Brick, Construction Materials 322631 125mm x 2.4mm 12,200rpm	
Type Description Application Materials Part Number Size Max Rating	5" Diameter Bonded Abrasive Grinding Disc for Metal Depressed Centre High Performance, minimal vibration & long life Grinding Pipe, Structural, Solid or Plate Steel, Stainless Steel GW578DCS 125mm x 6.4mm 12,200rpm	
Type Description Application Materials Part Number Size Max Rating	5" Diameter Bonded Abrasive Grinding Disc for Stone Depressed Centre High Performance, minimal vibration & long life Grinding Masonry, Stone, Concrete Stone, Brick, Concrete, Ceramics GW578DCM 125mm x 6.4mm 12,200rpm	
Type Description Application Materials Part Number Size Max Rating	5" Diameter Bonded Abrasive Cutting Disc for Metal Depressed Centre High performance, minimal vibration & long life Cutting Pipe, Structural, Solid and Plate Steel, Stainless Steel CW578DCS 125mm x 2.5mm 12,200rpm	



All Hydraulic Tools, parts, accessories and allied equipment are subject to design improvements, specification and price changes at any time without notice and with no obligation to units already sold. Weights, dimensions and operating specifications listed herein are subject to change without notice. Where specifications are critical to your application, please consult us.

ACCESSORIES

<p>Type Description Application Materials Part Number Size Max Rating</p>	<p>Cup Wire Brush 100mm Crimped Steel Bristles General purpose cup wire brush Surface preparation, Rust removal, Cleaning Various, Inc. Steel, Stainless Steel & Glass Fiber CWB100-CB14 100mm x M14 Threaded Bore 8,500rpm</p>	
<p>Type Description Application Materials Part Number Size Max Rating</p>	<p>Cup Wire Brush 100mm Twisted Knot Steel Bristles Hard wearing cup brush with good material removal De-burring, De-scaling, Marine growth removal, Paint removal Various, Inc. Steel, Stainless Steel & Glass Fiber CWB100-TK14 100mm x M14 Threaded Bore 8,500rpm</p>	
<p>Type Description Application Materials Part Number Sizes Max Rating</p>	<p>Bevel Wire Brush 100mm Twisted Knot Steel Bristles Hard wearing bevel brush with good material removal De-burring, De-scaling, Marine growth removal, Paint removal Various, Inc. Steel, Stainless Steel & Glass Fiber BWB100-TK14 100mm x M14 Threaded Bore 12,500rpm</p>	
<p>Type Description Application Materials Part Number Size Max Rating</p>	<p>5" Diamond Grinding Cup DS300 B Cup Grinding Wheel with 18 segments High Stock Removal Performance Concrete, Stone, Construction Material 325362 125mm x 5mm 12,200rpm</p>	

All Hydraulic Tools, parts, accessories and allied equipment are subject to design improvements, specification and price changes at any time without notice and with no obligation to units already sold. Weights, dimensions and operating specifications listed herein are subject to change without notice. Where specifications are critical to your application, please consult us.

ACCESSORIES

Type Description Application Materials Part Number Size Max Rating	5" Rapid Strip Disc DPC, Extra Coarse, Harder Density Synthetic fibers and coarse silicon carbide grains Light Marine Growth, Rust & Paint removal. Surface Preparation Various, Inc. Steel, Stainless Steel & Glass Fiber RSD30655 125mm DPC 12,000rpm													
Type Description Application Materials Part Number Sizes Grit Max Rating	5" Conical Fiber Discs (40/80/120 Grit) DPC Zirconium, excellent material removal and long life Ideal for edge grinding, surface preparation & cleaning, De-rusting Steel, Stainless Steel <table border="0" style="width: 100%;"> <tr> <td>CFD02315</td> <td>CFD02318</td> <td>CFD02326</td> </tr> <tr> <td>125mm</td> <td>125mm</td> <td>125mm</td> </tr> <tr> <td>40-Grit</td> <td>80-Grit</td> <td>120-Grit</td> </tr> <tr> <td>12,250rpm</td> <td>12,250rpm</td> <td>12,250rpm</td> </tr> </table>	CFD02315	CFD02318	CFD02326	125mm	125mm	125mm	40-Grit	80-Grit	120-Grit	12,250rpm	12,250rpm	12,250rpm	
CFD02315	CFD02318	CFD02326												
125mm	125mm	125mm												
40-Grit	80-Grit	120-Grit												
12,250rpm	12,250rpm	12,250rpm												
Type Description Application Materials Part Number Size Max Rating	4" Swirl-Off Stainless Steel housing with 21 cutters De-Scaling, Marine Growth Removal, Paint Removal Various, Inc. Steel, Stainless Steel & Glass Fiber 50400MM 100mm x M14 Threaded Bore 6,000rpm													

All Hydraulic Tools, parts, accessories and allied equipment are subject to design improvements, specification and price changes at any time without notice and with no obligation to units already sold. Weights, dimensions and operating specifications listed herein are subject to change without notice. Where specifications are critical to your application, please consult us.

HYDRAULIC HOSE RECOMMENDATIONS

We offer a large range of hydraulic hose sets suitably designed and constructed for use with the GR05 Angle Grinder as well as most other handheld hydraulic tools. These hose sets are offered to suit two Hydraulic Power Unit (HPU) coupling size arrangements, hose length compatibility will depend on the specifics of the HPU. All our hydraulic hose sets and their lengths have been carefully configured to satisfy the hydraulic flow & pressure demands of this and all other handheld hydraulic tools we offer. Please contact us should you wish to discuss the specifications of any of our hose sets further.

Hydraulic Hose Sets for HPU fitted with 1/2" Flat Face Hydraulic Couplers					
Part No.	Length	Pressure Hose	Return Hose	Coupling HPU	Coupling Tool
HS07M08B3-FF	7m	1/2 R2	1/2 R2	1/2"	1/2"
HS10M08B3-FF	10m	1/2 R2	1/2 R2	1/2"	1/2"
HS15M10B3-FF	15m	5/8 R2	5/8 R2	1/2"	1/2"
HS20M10B3-FF	20m	5/8 R2	5/8 R2	1/2"	1/2"
HS25M10B3-FF	25m	5/8 R2	5/8 R2	1/2"	1/2"
HS30M10B3-FF	30m	5/8 R2	5/8 R2	1/2"	1/2"

Hydraulic Hose Sets for HPU fitted with 3/4" Flat Face Hydraulic Couplers					
Part No.	Length	Pressure Hose	Return Hose	Coupling HPU	Coupling Tool
HS030M1012B2-FF	30m	5/8 R2	3/4 R1	3/4"	1/2"
HS050M1012B2-FF	50m	5/8 R2	3/4 R1	3/4"	1/2"
TS050M1012B2-FF	50m Thermoplastic	5/8 R8	3/4 R7	3/4"	1/2"
HS075M1216B2-FF	75m	3/4 R2	1 R1	3/4"	1/2"
HS100M1216B2-FF	100m	3/4 R2	1 R1	3/4"	1/2"

All hydraulic hose sets are fitted with flat face hydraulic couplings and commissioned with ISO32 mineral hydraulic oil, plug & play on receipt. If required and on request we can also commission with biodegradable hydraulic oils.

EU DECLARATION OF CONFORMITY

DECLARATION OF CONFORMITY



I, the undersigned, hereby declare that the equipment specified hereunder:

Category: Hydraulic Angle Grinder
Make: Hopkins
Type: GR05
Serial Number: ALL



Has been manufactured in conformity with:

Directive / Standard	No.
Machinery Directive	2006/42/EC
EN ISO	11148-7:2012
EN ISO	12100:2010
EN ISO	15744:2008
EN ISO	28927-1:2019

Special Provisions: None

EC Hopkins Limited, Woodgate Business Park, Birmingham B32 3DB, UK

Name: Andrew Gray

Signature: 

Position: Technical Manager

Date: 3 November 2025

WARRANTY

This product is guaranteed (subject to normal wear and tear) against defective parts and faulty workmanship for a period of 12 months from date of purchase.

It does not cover: -

- Parts already covered by original equipment manufacturers own warranties already in place
- Failure of parts due to lack of maintenance and services
- Any failure due to non-genuine parts fitted
- Rubber products
- Product subject to misuse/abuse or being neglected in any way
- Being modified in any way without prior written consent from EC Hopkins Ltd

In case of disagreement between parties as to whether it is or is not warranty, the failed part will be returned to our supplier for inspection. The findings by that supplier as to why the part failed will be binding.

With an ongoing design and development program EC Hopkins Ltd reserve the right to alter the design or specification of any product without prior notice.

NOTES

Hopkins

EC HOPKINS LTD

82 Kettles Wood Drive
Woodgate Business Park
Birmingham, B32 3DB, UK

+44 (0)121 506 6095
enquiries@echopkins.com
www.echopkins.com